



Nugget ice is generated through a vertical cylinder, with an internal turning auger which scrapes the ice from the internal surface of the evaporator, lifting it up an ice extruder which compresses the ice shavings into a cylinder.

High production modular nugget ice maker.
Up to 255kg production per 24/hr of nugget ice.
Head only.
Stainless steel cabinet.
Complete with water & drain hoses.
10 AMP power supply.



ICE PRODUCTION

Air Cooled Unit

Air Temp.	Water Temperature			
				
°C	32°	21°	15°	10°
°F	90°	70°	60°	50°
10°	230	250	260	270
50°	507	551	573	595
21°	225	245	255	265
70°	496	540	562	584
32°	195	215	225	235
90°	430	474	496	518
38°	170	190	200	210
100°	375	419	441	463

CUBE TYPE

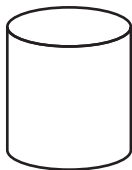

1g
NUGGET ICE
11 mm Ø x 13 mm H
8% residual water content

Nugget ice is both compact and chewable. It's the ideal ice for cocktails like caipirinha, mojito and caipiroska. It's easy to measure like flake ice but it's much less wet

SUGGESTED STORAGE BIN



BH56
Stainless steel storage bin.
120kg capacity.

DIMENSIONS

W x D x H (mm)
538 x 663 x 650





OPERATING REQUIREMENTS













220-240/50/1



R404a GWP=3922

MIN		MAX
10°C (50°F)		40°C (104°F)
5°C (41°F)		35°C (95°F)
- 10 %		+ 10 %
1 Bar (14 psi)		5 Bar (70 psi)

SPECIFICATIONS

	 cond	 comp. W	 ABS. W	 Fuse	 kWh/100kg	 L / hr	 kg	 lbs	 kg	 lbs
G270 A		2650	1200	16	11.6	9	78	172	87	192

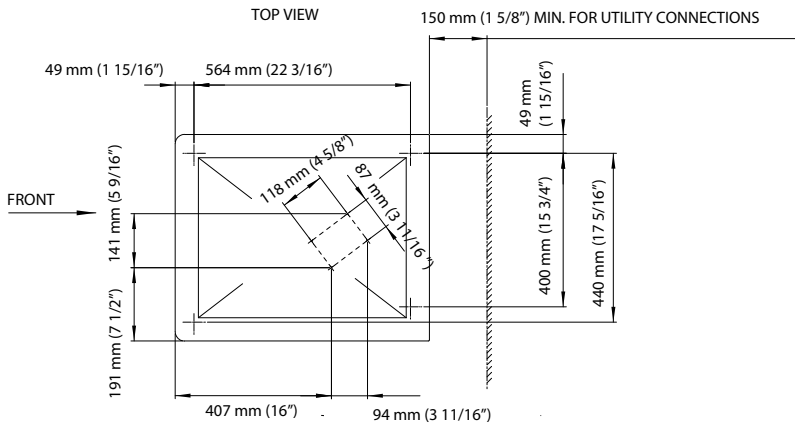
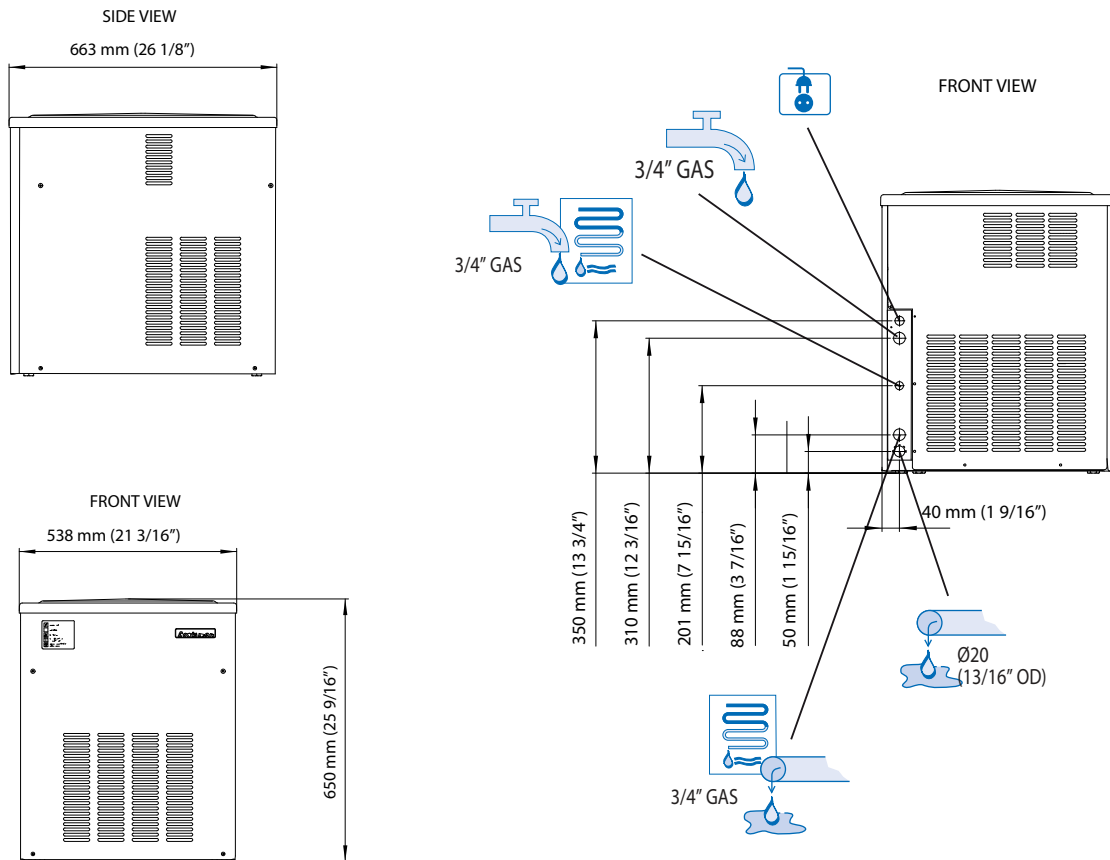

NOTE:
IF THE UNIT IS INSTALLED AS A BUILT-IN/UNDERCOUNTER, BETWEEN 5 AND 10 mm ON EACH SIDE MUST BE CONSIDERED TO ALLOW FOR EASE OF INSTALLATION